

**PRODUCT SPECIFICATIONS**

**Cutoff** 45° visual cutoff to lamp and lamp image  
**Trims Style** Die Cast Self Flanged and Flangeless reflectors utilize precision wound double torsion springs for tight, secure fit to ceiling • Flange is same finish as reflector unless optional painted white flange is specified  
**Lens** Lampholder accommodates up to three (3) 2" captive accessory lenses • Supplied with stippled clear uniformity lens.  
**Socket** Ceramic bi-pin socket with double blade nickel alloy contacts • Quick disconnect for simplified maintenance.  
**Lamp** One 50W MR16 lamp max for IC43SQ. One 75W MR16 lamp max for TC43SQ (TC943SQ).

**Adjustability** Acu-Aim™ precision geared hot-aiming achieves 370° rotation, 45° tilt • Optimized center lamp beam optics translates lamp forward as it is aimed off nadir, ensuring maximum light and low brightness • Black aiming mechanism with shield prevents visibility into fixture and preserves dark aperture • Shield hinges out of way to facilitate maintenance.

**Transformer** Available with either magnetic or electronic transformers, capable of 120V or 277V input.

**Magnetic Transformer** Hatch LT12-75-JLG-1 (120V) or Hatch LT12-75-JLG-2 (277V), high efficiency (>90%) dual tap magnetic, toroidal transformer (has boost tap to compensate for dimmer losses, improving color temperature and lumen output).

**Electronic Transformer** IC43SQ available with Hatch RS12-60M, 120V high efficiency, high power factor electronic transformer. TC43SQ and TC943SQ available with GE LET 75 (120V) or Hatch RS12-80 (277V) electronic transformers.

**Dimming** May be dimmed using dimmers specifically designed for low voltage magnetic or electronic transformers; consult factory or dimmer manufacturer for additional information.

**Codes/Labels** UL and cUL listed for direct contact with insulation, through-branch wiring, damp locations (wet location with approved trims) • Meets energy code Air Leakage requirements per ASTM E283 • Product thermally protected • Union made.

**Bar Hangers / Mounting Brackets** IC43SQ and TC43SQ features patented (US Patent 8,038,113) Pro-VI™ bar hanger system, permitting quick placement of housing with 24" on-center joists or suspended ceilings. TC943SQ features vertically adjustable mounting brackets (butterfly brackets).

**Junction Box** Rated for 4 No. 12 AWG 90° C through branch circuit conductors and includes (5) ½", (1) ¾", and (4) Non-metallic sheathed cable knock-outs • Push-in electrical connectors for field connections.

**Housing/Mounting Frame** Steel plaster frame and aluminum housing painted black for visually dark interior • V-Notch in plaster frame aids fixture alignment during installation • Patent Pending Tru-Line™ Adjustment Mechanism featuring +/- ½" translation and +/- 45° aperture rotation aids fixture alignment after installation, prior to drywall.

**Ceiling Thickness** ½" – 2" ceiling.  
 Specifications subject to change without notice.

**3" MR16 UNIVERSAL RECESSED  
 ADJUSTABLE/DOWNLIGHT/WALL WASH**  
 MR16 Halogen  
**IC43SQ / TC43SQ / TC943SQ**



**DIMENSIONS**

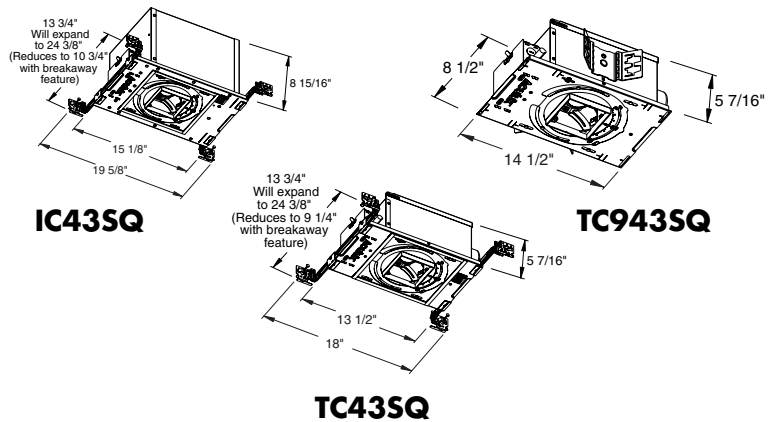

4 1/8" SQUARE CEILING CUTOUT  
 (4 1/4" SQUARE FOR FLANGELESS)

**ORDERING INFORMATION**

Example: IC43SQ ELV 120 35QABV BD BLSF FMA35Q/087

Series / Housing Style	Transformer	Voltage	Options
IC43SQ 3" Aculux Square MR16 IC Rated	ELV Electronic Low Voltage	120	CP Chicago Plenum
TC43SQ 3" Aculux Square MR16 Non-IC	MLV Magnetic Low Voltage	277	
TC943SQ 3" Aculux Square MR16 Non-IC Butterfly Brackets			

HOUSING INFO

TRIM OPTIONS

Trim Style	Reflector Finish	Flange Style / Finish	Environment	Ceiling Installation
<b>ADJUSTABLE ACCENT</b>	<b>BD</b> <sup>2</sup> Black Diffuse <b>CD</b> <sup>2</sup> Clear Diffuse <b>WTD</b> <sup>2</sup> Wheat Diffuse <b>W</b> <sup>2</sup> White Paint <b>BS</b> <sup>1</sup> Black Specular	<b>FLANGED</b> <b>SF</b> <sup>2</sup> Self Flanged (same finish as reflector) <b>WHSF</b> Self Flanged, White painted flange <b>BLSF</b> <sup>1</sup> Self Flanged, Black painted flange  <b>FLANGELESS</b> <sup>3</sup> <b>FM</b> <sup>2</sup> Flangeless <b>WHFM</b> <sup>1</sup> Flangeless, White trim <b>BLFM</b> <sup>1</sup> Flangeless, Black trim	<b>WET</b> Wet location	<b>SELF-FLANGED</b>  <b>CTA35Q/125</b> Ceiling ≤ .875" <b>CTA35Q/163</b> Ceiling 0.875" - 1.25" <b>CTA35Q/200</b> Ceiling 1.25" - 1.625" Ceiling 1.625" - 2"  <b>FLANGELESS, GYPSUM</b> <b>FMA35Q/087</b> Ceiling ≤ .875" <b>FMA35Q/125</b> Ceiling 0.875" - 1.25" <b>FMA35Q/163</b> Ceiling 1.25" - 1.625" <b>FMA35Q/200</b> Ceiling 1.625" - 2"  <b>FLANGELESS, WOOD/STONE/TILE</b> <sup>4</sup> <b>SFM35Q/100 (B,W)</b> Ceiling ≤ 1" <b>SFM35Q/138 (B,W)</b> Ceiling 1" - 1.375" <b>SFM35Q/163 (B,W)</b> Ceiling 1.375" - 1.625"
<b>DOWNLIGHT</b> <b>3SQD</b> 3" Square Downlight Reflector <b>3SQDBV</b> 3" Square Downlight Bevel <b>3SQDPIN</b> 3" Square Downlight Pinhole				
<b>WALL WASH</b> <b>3SQWW</b> 3" Square Lensed Wall Wash				

NOTES











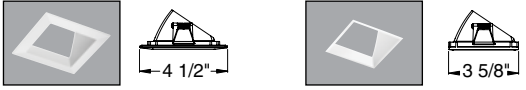



**Ordering Notes**  
<sup>1</sup> Available with 35QABV, 35QAPIN, 35QDBV, 35QDPIN only  
<sup>2</sup> Available with 35QA, 35QD, 35QWW only  
<sup>3</sup> For Flangeless trims, specify flangeless ceiling installation (FMA3 or SFM3)  
<sup>4</sup> Specify finish : B = Black, W = White.

**3" MR16 UNIVERSAL RECESSED  
ADJUSTABLE/DOWNLIGHT/WALL WASH**

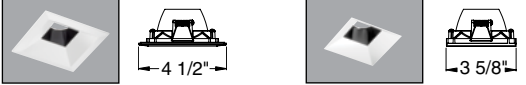
MR16 Halogen

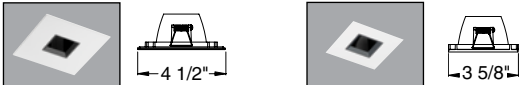
**IC43SQ / TC43SQ / TC943SQ**

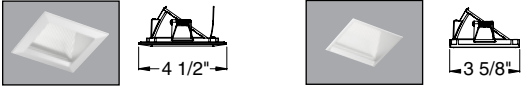
**TRIM SELECTION**

ADJUSTABLE ACCENT					MAX. LAMP RATING
<p><b>35QA Square Adjustable Reflector</b></p>  <p>Self-Flanged      Flangeless      Aperture: 3 1/4"</p> 					
<p><b>35QABV Square Adjustable Bevel</b></p>  <p>Self-Flanged      Flangeless      Aperture: 1 3/4"</p> 					
<p><b>35QAPIN Square Adjustable Pinhole</b></p>  <p>Self-Flanged      Flangeless      Aperture: 1 1/4"</p> 					
DOWNLIGHT TRIMS					
<p><b>35QD Square Downlight Reflector</b></p>  <p>Self-Flanged      Flangeless      Aperture: 3 1/4"</p> 				<p><b>IC-Rated (IC43SQ) :</b> 50W MR16</p> <hr/>	
<p><b>35QDBV Square Downlight Bevel</b></p>  <p>Self-Flanged      Flangeless      Aperture: 1 3/4"</p> 				<p><b>Non-IC (TC43SQ) :</b> 75W MR16</p> <hr/>	
<p><b>35QDPIN Square Downlight Pinhole</b></p>  <p>Self-Flanged      Flangeless      Aperture: 1 1/4"</p> 				<p><b>Non-IC (TC943SQ) :</b> 75W MR16</p>	
WALL WASH					
<p><b>35QWW Square Wall Wash</b></p>  <p>Self-Flanged      Flangeless      Aperture: 3 1/4"</p> 					

\* With WET option

**3" MR16 UNIVERSAL RECESSED  
ADJUSTABLE/DOWNLIGHT/WALL WASH**

MR16 Halogen

**IC43SQ / TC43SQ / TC943SQ**

**ACCESSORIES**

Cat. #	Description	Cat. #	Description
<b>CGF 200 MPINK</b>	Med. Pink Color Filter	<b>DGF 200 MAGEN</b>	Magenta Dichroic Lens
<b>CGF 200 WRED</b>	Warm Red Color Filter	<b>DGF 200 CYAN</b>	Blue Green Dichroic Lens
<b>CGF 200 DLTBLUE</b>	Daylight Blue Color Filter	<b>DCCF 200 HL4250</b>	Daylight Blue Correction Lens
<b>CGF 200 MBLU</b>	Med. Blue Color Filter	<b>DIFF 200</b>	Diffuse Spread Lens
<b>CGF 200 MAMB</b>	Med. Amber Color Filter	<b>SOLITE 200</b>	Uniformity Lens
<b>CGF 200 MGRN</b>	Med. Green Color Filter	<b>UVF 200</b>	UV Filter Lens
<b>DGF 200 DRED</b>	Red Dichroic Lens	<b>PRISM 200</b>	Prismatic Lens
<b>DGF 200 MGRN</b>	Med. Green Dichroic Lens	<b>LSPREAD 200</b>	Linear Spread Lens
<b>DGF 200 MBLU</b>	Med. Blue Dichroic Lens	<b>HCLBL 200</b>	Hexcell Louver
<b>DGF 200 DYEL</b>	Yellow Dichroic Lens		

*To order, specify catalog number.*

**3" MR16 UNIVERSAL RECESSED  
ADJUSTABLE TRIMS**

MR16 Halogen

**IC43SQ / TC43SQ / TC943SQ**

**PHOTOMETRICS**

**CBCP** · Centerbeam candlepower  
**FC** · Footcandles at beam center (aim point)

In vertical aiming applications, aim point (X) is determined by dividing distance from the wall (D) by the tangent of the desired aim angle (A) (0.5774 for 30°, 1.0 for 45°).

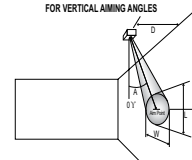
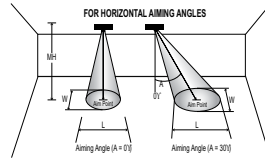

Lamp	Beam Type	Beam Spread°	Rated Life	CBCP	0°			30°			30°			45°						
					MH	FC	L	W	FC	L	W	D	FC	X	L	W	FC	X	L	W
37W MR16 Halogen IR	NSP	10°	5000	12500	6	347	1.0	1.0	226	1.4	1.2	3	174	5.2	2.1	1.0	491	3.0	1.1	0.7
					8	195	1.4	1.4	127	1.9	1.6	4	98	6.9	2.9	1.4	276	4.0	1.4	1.0
					10	125	1.7	1.7	81	2.3	2.0	5	63	8.7	3.6	1.7	177	5.0	1.8	1.2
	NFL	25°	5000	4400	4	275	1.8	1.8	179	2.4	2.0	2	138	3.5	4.2	1.8	389	2.0	1.9	1.3
					6	122	2.7	2.7	79	3.6	3.1	3	61	5.2	6.2	2.7	173	3.0	2.8	1.9
					8	69	3.5	3.5	45	4.8	4.1	4	34	6.9	8.3	3.5	97	4.0	3.7	2.5
	FL	35°	5000	2200	3	244	1.9	1.9	159	2.6	2.2	2	69	3.5	7.2	2.5	194	2.0	2.8	1.8
					4	138	2.5	2.5	89	3.5	2.9	3	31	5.2	10.8	3.8	86	3.0	4.2	2.7
					6	61	3.8	3.8	40	5.2	4.4	4	17	6.9	14.4	5.0	49	4.0	5.6	3.6
42W MR16 Halogen	VNSP	9°	3500	12300	8	192	1.3	1.3	125	1.7	1.5	4	96	6.9	2.6	1.3	272	4.0	1.3	0.9
					10	123	1.6	1.6	80	2.1	1.8	5	62	8.7	3.2	1.6	174	5.0	1.6	1.1
					12	85	1.9	1.9	55	2.5	2.2	6	43	10.4	3.8	1.9	121	6.0	1.9	1.3
					14	63	2.2	2.2	41	2.9	2.5	7	31	12.1	4.5	2.2	89	7.0	2.2	1.6
	NFL	25°	6000	3200	4	200	1.8	1.8	130	2.4	2.0	2	100	3.5	4.2	1.8	283	2.0	1.9	1.3
					6	89	2.7	2.7	58	3.6	3.1	3	44	5.2	6.2	2.7	126	3.0	2.8	1.9
					8	50	3.5	3.5	32	4.8	4.1	4	25	6.9	8.3	3.5	71	4.0	3.7	2.5
	FL	40°	6000	1700	3	189	2.2	2.2	123	3.0	2.5	2	53	3.5	9.7	2.9	150	2.0	3.4	2.1
					4	106	2.9	2.9	69	4.1	3.4	3	24	5.2	14.5	4.4	67	3.0	5.0	3.1
6					47	4.4	4.4	31	6.1	5.0	4	13	6.9	19.3	5.8	38	4.0	6.7	4.1	
50W MR16 Halogen IR Lensed	SP	10°	5000	15000	6	417	1.0	1.0	217	1.4	1.2	3	208	5.2	2.1	1.0	589	3.0	1.1	0.7
					8	234	1.4	1.4	152	1.9	1.6	4	117	6.9	2.9	1.4	331	4.0	1.4	1.0
					10	150	1.7	1.7	97	2.3	2.0	5	75	8.7	3.6	1.7	212	5.0	1.8	1.2
					12	104	2.1	2.1	68	2.8	2.4	6	52	10.4	4.3	2.1	147	6.0	2.1	1.5
	NFL	25°	5000	5700	4	356	1.8	1.8	231	2.1	2.0	2	178	3.5	4.2	1.8	504	2.0	1.9	1.3
					6	158	2.7	2.7	103	3.6	3.1	3	79	5.2	6.2	2.7	224	3.0	2.8	1.9
					8	89	3.5	3.5	58	4.8	4.1	4	45	6.9	8.3	3.5	126	4.0	3.7	2.5
	FL	35°	5000	2850	3	317	1.9	1.9	206	2.6	2.2	2	89	3.5	7.2	2.5	252	2.0	2.8	1.8
					4	178	2.5	2.5	116	3.5	2.9	3	40	5.2	10.8	3.8	112	3.0	4.2	2.7
6					79	3.8	3.8	51	5.2	4.4	4	22	6.9	14.4	5.0	63	4.0	5.6	3.6	
71W MR16 Halogen	SP	15°	4000	11500	6	319	1.6	1.6	207	2.1	1.8	3	160	5.2	3.3	1.6	452	3.0	1.6	1.1
					8	180	2.1	2.1	117	2.8	2.4	4	90	6.9	4.4	2.1	254	4.0	2.1	1.5
					10	115	2.6	2.6	75	3.5	3.0	5	58	8.7	5.6	2.6	163	5.0	2.7	1.9
					12	80	3.2	3.2	52	4.2	3.6	6	40	10.4	6.7	3.2	113	6.0	3.2	2.2
	NFL	25°	4000	5500	4	344	1.8	1.8	223	2.4	2.0	2	172	3.5	4.2	1.8	486	2.0	1.9	1.3
					6	153	2.7	2.7	99	3.6	3.1	3	76	5.2	6.2	2.7	216	3.0	2.8	1.9
					8	86	3.5	3.5	56	4.8	4.1	4	43	6.9	8.3	3.5	122	4.0	3.7	2.5
	FL	40°	4000	2200	3	244	2.2	2.2	159	3.0	2.5	2	69	3.5	9.7	2.9	194	2.0	3.4	2.1
					4	138	2.9	2.9	89	4.1	3.4	3	31	5.2	14.5	4.4	86	3.0	5.0	3.1
6					61	4.4	4.4	40	6.1	5.0	4	17	6.9	19.3	5.8	49	4.0	6.7	4.1	

The beam spread in degrees and the beam "L" and "W" in the following tables are computed at 50% of centerbeam candlepower and represent areas of "effective illumination."

3SQD Square Downlight Reflector



Self-Flanged



Flangeless



# 3" MR16 UNIVERSAL RECESSED DOWNLIGHT

MR16 Halogen

## IC43SQ / TC43SQ / TC943SQ with 3SQD Trim

### PHOTOMETRICS

#### PHOTOMETRIC REPORT

Catalog Number: IC43SQ 3SQD CD SF

Test Number: PT01102001

Total Luminaire Efficiency: 68.8%

Luminaire Spacing Criteria: 0.52

Luminaire: Clear diffuse finish, square downlight trim. Open aperture.

Lamps: One 37MR16/IR/FL35, rated at 800 total lumens.

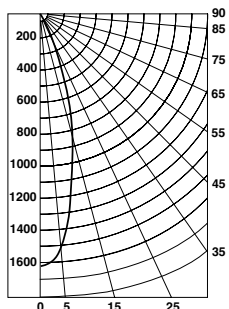

#### Candlepower Distribution (Candelas)

Angle	Candela	Lumens
0°	1609	
5°	1512	144
15°	866	246
25°	278	129
35°	41	26
45°	6	5
55°	1	1
65°	0	0
75°	0	0
85°	0	0

#### Initial Footcandles

Distance to Illuminated Plane (Feet)	Footcandles Beam Center	Footcandles Beam Edge	Beam Diameter
6'	44.7	19.8	3.5'
7'	32.8	14.6	4.0'
8'	25.1	11.1	4.6'
9'	19.9	8.8	5.2'
10'	16.1	7.1	5.8'
11'	13.3	5.9	6.4'
12'	11.2	5.0	6.9'
13'	9.5	4.2	7.5'
14'	8.2	3.6	8.1'
15'	7.2	3.2	8.7'

#### Luminance Data

Ang in Deg	Footlamberts	Candela/M <sup>2</sup>
45	388	1330
55	75	256
65	0	0
75	0	0
85	0	0

#### Zonal Lumen Summary

Zone	Lumens	%Lamp	%Fixture
0-30°	519	64.8	94.2
0-40°	545	68.1	98.9
0-60°	551	68.8	100.0
0-90°	551	68.8	100.0
90-180°	0	0.0	0.0
0-180°	551	68.8	100.0

#### AVERAGE INITIAL FOOTCANDLES

Reflectances: 80% Ceiling, 50% Walls, 20% Floors

Luminaire Spacing	Room Cavity Ratio		
	RCR1	RCR3	RCR5
4' x 4'	39	35	32
5' x 5'	25	22	20
6' x 6'	17	16	14
7' x 7'	14	13	12
8' x 8'	11	10	9
9' x 9'	8	8	7
10' x 10'	6	6	5
12' x 12'	4	4	4

#### COEFFICIENTS OF UTILIZATION - % (Zonal Cavity Method)

Effective Floor Reflectance 20%

PCC	80		70		50		30		10		0							
	PW	70	50	30	10	70	50	30	10	50	30	10	0					
0	82	82	82	82	80	80	80	80	76	76	76	73	73	73	70	70	70	69
1	79	77	76	75	77	76	75	74	73	72	71	71	70	69	68	68	67	66
2	76	73	71	69	75	72	70	69	70	69	67	68	67	66	66	65	64	63
3	73	70	67	65	72	69	67	65	67	65	64	66	64	63	64	63	62	61
4	71	67	64	62	70	66	63	61	65	63	61	64	62	60	62	61	59	59
5	68	64	61	59	68	64	61	59	62	60	58	61	59	58	60	59	57	56
6	66	62	58	56	65	61	58	56	60	58	56	59	57	55	58	56	55	54
7	64	59	56	54	63	59	56	54	58	55	54	57	55	53	57	55	53	52
8	62	57	54	52	61	57	54	52	56	53	52	55	53	51	55	53	51	50
9	60	55	52	50	59	55	52	50	54	52	50	54	51	50	53	51	49	49
10	58	53	50	48	58	53	50	48	52	50	48	52	50	48	52	49	48	47

#### PHOTOMETRIC REPORT

Catalog Number: TC43SQ (TC943SQ) 3SQD CD SF

Test Number: PT01102601

Total Luminaire Efficiency: 69.8%

Luminaire Spacing Criteria: 0.54

Luminaire: Clear diffuse finish, square downlight trim. Open aperture.

Lamps: One 50MR16/IR/FL35/C, rated at 1200 total lumens.

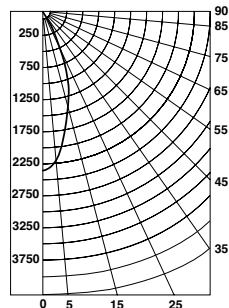

#### Candlepower Distribution (Candelas)

Angle	Candela	Lumens
0°	2371	
5°	2200	210
15°	1326	376
25°	428	198
35°	69	43
45°	11	8
55°	3	2
65°	0	0
75°	0	0
85°	0	0

#### Initial Footcandles

Distance to Illuminated Plane (Feet)	Footcandles Beam Center	Footcandles Beam Edge	Beam Diameter
6'	65.9	28.9	3.6'
7'	48.4	21.2	4.2'
8'	37.0	16.2	4.8'
9'	29.3	12.8	5.5'
10'	23.7	10.4	6.1'
11'	19.6	8.6	6.7'
12'	16.5	7.2	7.3'
13'	14.0	6.1	7.9'
14'	12.1	5.3	8.5'
15'	10.5	4.6	9.1'

#### Luminance Data

Ang in Deg	Footlamberts	Candela/M <sup>2</sup>
45	651	2229
55	198	677
65	0	0
75	0	0
85	0	0

#### Zonal Lumen Summary

Zone	Lumens	%Lamp	%Fixture
0-30°	784	65.3	93.6
0-40°	827	68.9	98.7
0-60°	838	69.8	100.0
0-90°	838	69.8	100.0
90-180°	0	0.0	0.0
0-180°	838	69.8	100.0

#### AVERAGE INITIAL FOOTCANDLES

Reflectances: 80% Ceiling, 50% Walls, 20% Floors

Luminaire Spacing	Room Cavity Ratio		
	RCR1	RCR3	RCR5
4' x 4'	59	53	49
5' x 5'	37	34	31
6' x 6'	26	24	22
7' x 7'	21	19	18
8' x 8'	17	15	14
9' x 9'	13	12	11
10' x 10'	9	9	8
12' x 12'	7	6	5

#### COEFFICIENTS OF UTILIZATION - % (Zonal Cavity Method)

Effective Floor Reflectance 20%

PCC	80		70		50		30		10		0							
	PW	70	50	30	10	70	50	30	10	50	30	10	0					
0	83	83	83	83	81	81	81	81	78	78	78	74	74	74	71	71	71	70
1	80	78	77	76	78	77	76	75	74	73	72	72	71	70	69	69	68	67
2	77	74	72	70	76	73	71	70	71	69	68	69	68	67	67	66	65	64
3	74	71	68	66	73	70	67	65	68	66	64	67	65	63	65	64	63	62
4	72	68	65	62	71	67	64	62	66	63	61	64	62	61	63	61	60	59
5	69	65	62	59	68	64	61	59	63	61	59	62	60	58	61	59	58	57
6	67	62	59	57	66	62	59	56	61	58	56	60	58	56	59	57	55	55
7	65	60	57	54	64	59	56	54	59	56	54	58	55	54	57	55	53	53
8	63	58	54	52	62	57	54	52	56	54	52	56	53	52	55	53	51	51
9	61	55	52	50	60	55	52	50	55	52	50	54	52	50	54	51	50	49
10	59	54	50	48	58	53	50	48	53	50	48	52	50	48	52	50	48	47

3SQDBV Square Downlight Bevel

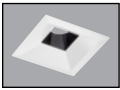

Self-Flanged

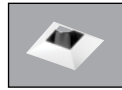

Flangeless



3" MR16 UNIVERSAL RECESSED  
DOWNLIGHT

MR16 Halogen

IC43SQ / TC43SQ / TC943SQ with 3SQDBV Trim

PHOTOMETRICS

PHOTOMETRIC REPORT

Catalog Number: IC43SQ 3SQDBV BS WHSF

Test Number: PT01102103

Total Luminaire Efficiency: 58.1%

Luminaire Spacing Criteria: 0.3

Luminaire: 1 3/4" square regressed pinhole trim. Open aperture.

Lamps: One 37MR16/IR/SP10/C, rated at 800 total lumens.

Initial Footcandles

Distance to Illuminated Plane (Feet)	Footcandles Beam Center	Footcandles Beam Edge	Beam Diameter
6'	104.5	51.1	1.5'
7'	76.8	37.5	1.7'
8'	58.8	28.7	2.0'
9'	46.4	22.7	2.2'
10'	37.6	18.4	2.5'
11'	31.1	15.2	2.7'
12'	26.1	12.8	3.0'
13'	22.3	10.9	3.2'
14'	19.2	9.4	3.4'
15'	16.7	8.2	3.7'

AVERAGE INITIAL FOOTCANDLES

Reflectances: 80% Ceiling, 50% Walls, 20% Floors

Luminaire Spacing	Room Cavity Ratio		
	RCR1	RCR3	RCR5
4' x 4'	33	31	29
5' x 5'	21	20	19
6' x 6'	15	14	13
7' x 7'	12	11	10
8' x 8'	9	9	8
9' x 9'	7	7	6
10' x 10'	5	5	5
12' x 12'	4	3	3

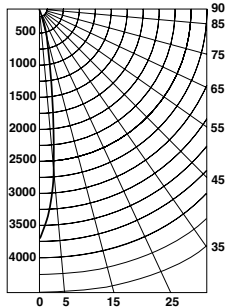

Candlepower Distribution (Candelas)

Angle	Candela	Lumens
0°	3762	
5°	2633	251
15°	541	153
25°	117	54
35°	10	6
45°	0	0
55°	0	0
65°	0	0
75°	0	0
85°	0	0

Luminance Data

Ang in Deg	Footlamberts	Candela/M <sup>2</sup>
45	0	0
55	0	0
65	0	0
75	0	0
85	0	0

Zonal Lumen Summary

Zone	Lumens	%Lamp	%Fixture
0-30°	459	57.4	98.7
0-40°	465	58.1	100.0
0-60°	465	58.1	100.0
0-90°	465	58.1	100.0
90-180°	0	0.0	0.0
0-180°	465	58.1	100.0

COEFFICIENTS OF UTILIZATION - % (Zonal Cavity Method)

Effective Floor Reflectance 20%

PCC	80		70		50		30		10		0							
	70	50	30	10	70	50	30	10	50	30	10	0						
0	69	69	69	69	68	68	68	68	65	65	65	62	62	62	59	59	59	58
1	67	66	65	64	66	65	64	63	63	62	61	60	60	59	58	58	58	57
2	65	63	62	61	64	63	61	60	61	60	59	59	58	58	58	57	56	56
3	64	61	60	58	63	61	59	58	59	58	57	58	57	56	57	56	55	54
4	62	59	57	56	61	59	57	56	58	56	55	57	55	54	56	55	54	53
5	61	58	56	54	60	57	55	54	56	55	54	56	54	53	55	54	53	52
6	59	56	54	53	59	56	54	53	55	54	52	55	53	52	54	53	52	51
7	58	55	53	52	58	55	53	51	54	52	51	54	52	51	53	52	51	50
8	57	54	52	50	56	54	52	50	53	51	50	53	51	50	52	51	50	49
9	56	53	51	49	55	52	51	49	52	50	49	52	50	49	51	50	49	48
10	55	52	50	48	54	51	50	48	51	49	48	51	49	48	50	49	48	48

PHOTOMETRIC REPORT

Catalog Number: TC43SQ (TC943SQ) 3SQDBV BS WHSF

Test Number: PT001102606

Total Luminaire Efficiency: 55.7%

Luminaire Spacing Criteria: 0.29

Luminaire: 1 3/4" square regressed pinhole trim. Open aperture.

Lamps: One 50MR16/IR/SP10/C, rated at 1200 total lumens.

Initial Footcandles

Distance to Illuminated Plane (Feet)	Footcandles Beam Center	Footcandles Beam Edge	Beam Diameter
6'	160.1	78.3	1.4'
7'	117.6	57.5	1.7'
8'	90.0	44.1	1.9'
9'	71.1	34.8	2.2'
10'	57.6	28.2	2.4'
11'	47.6	23.3	2.7'
12'	40.0	19.6	2.9'
13'	34.1	16.7	3.1'
14'	29.4	14.4	3.4'
15'	25.6	12.5	3.6'

AVERAGE INITIAL FOOTCANDLES

Reflectances: 80% Ceiling, 50% Walls, 20% Floors

Luminaire Spacing	Room Cavity Ratio		
	RCR1	RCR3	RCR5
4' x 4'	47	44	42
5' x 5'	30	28	27
6' x 6'	21	20	19
7' x 7'	17	16	15
8' x 8'	13	13	12
9' x 9'	10	10	9
10' x 10'	8	7	7
12' x 12'	5	5	5

COEFFICIENTS OF UTILIZATION - % (Zonal Cavity Method)

Effective Floor Reflectance 20%

PCC	80		70		50		30		10		0							
	70	50	30	10	70	50	30	10	50	30	10	0						
0	66	66	66	66	65	65	65	65	62	62	62	59	59	59	57	57	57	56
1	64	63	62	62	63	62	61	61	60	59	59	58	58	57	56	56	55	55
2	63	61	60	58	62	60	59	58	58	57	57	57	56	55	55	55	54	53
3	61	59	57	56	60	58	57	56	57	56	55	56	55	54	55	54	53	52
4	60	57	55	54	59	57	55	54	56	54	53	55	54	53	54	53	52	51
5	58	56	54	52	58	55	54	52	54	53	52	54	52	51	53	52	51	50
6	57	54	53	51	57	54	52	51	53	52	51	53	51	50	52	51	50	50
7	56	53	51	50	56	53	51	50	52	51	50	52	50	49	51	50	49	49
8	55	52	50	49	55	52	50	49	51	50	49	51	50	49	51	49	48	48
9	54	51	49	48	54	51	49	48	51	49	48	50	49	48	50	49	48	47
10	53	50	48	47	53	50	48	47	50	48	47	49	48	47	49	48	47	47

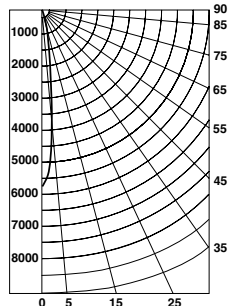

Candlepower Distribution (Candelas)

Angle	Candela	Lumens
0°	5763	
5°	4017	383
15°	761	216
25°	124	57
35°	14	9
45°	3	3
55°	0	0
65°	0	0
75°	0	0
85°	0	0

Luminance Data

Ang in Deg	Footlamberts	Candela/M <sup>2</sup>
45	716	2452
55	0	0
65	0	0
75	0	0
85	0	0

Zonal Lumen Summary

Zone	Lumens	%Lamp	%Fixture
0-30°	657	54.7	98.2
0-40°	666	55.5	99.6
0-60°	668	55.7	100.0
0-90°	668	55.7	100.0
90-180°	0	0.0	0.0
0-180°	668	55.7	100.0

3SQDPIN Square Downlight Pinhole



Self-Flanged



Flangeless



# 3" MR16 UNIVERSAL RECESSED DOWNLIGHT

MR16 Halogen

## IC43SQ / TC43SQ / TC943SQ with 3SQDPIN Trim

### PHOTOMETRICS

#### PHOTOMETRIC REPORT

Catalog Number: IC43SQ 3SQDPIN BS WHSF

Test Number: PTO1102101

Total Luminaire Efficiency: 43.7%

Luminaire Spacing Criteria: 0.3

Luminaire: 1 1/4" square pinhole trim. Open aperture.

Lamps: One 37MR16/IR/SP/10/C, rated at 800 total lumens.

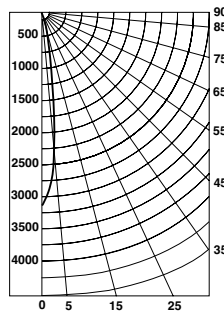

**Candlepower Distribution (Candelas)**

Angle	Candela	Lumens
0°	3193	
5°	2327	222
15°	387	110
25°	39	18
35°	0	0
45°	0	0
55°	0	0
65°	0	0
75°	0	0
85°	0	0

#### Initial Footcandles

Distance to Illuminated Plane (Feet)	Footcandles Beam Center	Footcandles Beam Edge	Beam Diameter
6'	88.7	43.3	1.5'
7'	65.2	31.8	1.8'
8'	49.9	24.4	2.0'
9'	39.4	19.3	2.3'
10'	31.9	15.6	2.5'
11'	26.4	12.9	2.8'
12'	22.2	10.8	3.0'
13'	18.9	9.2	3.3'
14'	16.3	8.0	3.5'
15'	14.2	6.9	3.8'

#### Luminance Data

Ang in Deg	Footlamberts	Candela/M <sup>2</sup>
45	0	0
55	0	0
65	0	0
75	0	0
85	0	0

#### Zonal Lumen Summary

Zone	Lumens	%Lamp	%Fixture
0-30°	350	43.7	100.0
0-40°	350	43.7	100.0
0-60°	350	43.7	100.0
0-90°	350	43.7	100.0
90-180°	0	0.0	0.0
0-180°	350	43.7	100.0

#### AVERAGE INITIAL FOOTCANDLES

Reflectances: 80% Ceiling, 50% Walls, 20% Floors

Luminaire Spacing	Room Cavity Ratio		
	RCR1	RCR3	RCR5
4' x 4'	25	24	22
5' x 5'	16	15	14
6' x 6'	11	10	10
7' x 7'	9	8	8
8' x 8'	7	7	6
9' x 9'	5	5	5
10' x 10'	4	4	4
12' x 12'	3	3	2

#### COEFFICIENTS OF UTILIZATION - % (Zonal Cavity Method)

Effective Floor Reflectance 20%

PCC	80		70		50		30		10		0							
	PW	70	50	30	10	70	50	30	10	50	30	10	0					
0	52	52	52	52	51	51	51	51	49	49	49	47	47	47	45	45	45	44
1	51	50	49	49	50	49	48	48	47	47	46	46	45	45	44	44	44	43
2	49	48	47	46	49	47	47	46	46	45	45	45	44	44	44	43	43	42
3	48	47	46	45	48	46	45	44	45	44	44	44	43	43	43	43	42	42
4	47	46	44	43	47	45	44	43	44	43	42	44	43	42	43	42	42	41
5	46	44	43	42	46	44	43	42	43	42	42	43	42	41	42	42	41	41
6	46	44	42	41	45	43	42	41	43	42	41	42	41	41	42	41	40	40
7	45	43	41	40	44	43	41	40	42	41	40	42	41	40	41	40	40	39
8	44	42	41	40	44	42	41	40	41	40	40	41	40	39	41	40	39	39
9	43	41	40	39	43	41	40	39	41	40	39	41	40	39	40	39	39	39
10	43	41	39	39	43	41	39	39	40	39	39	40	39	39	40	39	38	38

#### PHOTOMETRIC REPORT

Catalog Number: TC43SQ (TC943SQ) 3SQDPIN BS WHSF

Test Number: PTO01102601

Total Luminaire Efficiency: 39.1%

Luminaire Spacing Criteria: 0.29

Luminaire: 1 1/4" square pinhole trim. Open aperture.

Lamps: One 50MR16/IR/SP10/C, rated at 1200 total lumens.

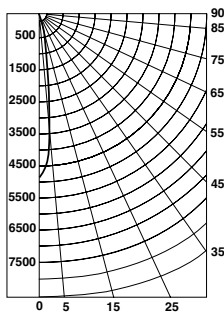

**Candlepower Distribution (Candelas)**

Angle	Candela	Lumens
0°	4860	
5°	3445	329
15°	431	122
25°	39	18
35°	0	0
45°	0	0
55°	0	0
65°	0	0
75°	0	0
85°	0	0

#### Initial Footcandles

Distance to Illuminated Plane (Feet)	Footcandles Beam Center	Footcandles Beam Edge	Beam Diameter
6'	135.0	66.1	1.4'
7'	99.2	48.6	1.7'
8'	75.9	37.2	1.9'
9'	60.0	29.4	2.1'
10'	48.6	23.8	2.4'
11'	40.2	19.7	2.8'
12'	33.7	16.5	2.8'
13'	28.8	14.1	3.1'
14'	24.8	12.1	3.3'
15'	21.6	10.6	3.5'

#### Luminance Data

Ang in Deg	Footlamberts	Candela/M <sup>2</sup>
45	0	0
55	0	0
65	0	0
75	0	0
85	0	0

#### Zonal Lumen Summary

Zone	Lumens	%Lamp	%Fixture
0-30°	469	39.1	100.0
0-40°	469	39.1	100.0
0-60°	469	39.1	100.0
0-90°	469	39.1	100.0
90-180°	0	0.0	0.0
0-180°	469	39.1	100.0

#### AVERAGE INITIAL FOOTCANDLES

Reflectances: 80% Ceiling, 50% Walls, 20% Floors

Luminaire Spacing	Room Cavity Ratio		
	RCR1	RCR3	RCR5
4' x 4'	34	32	30
5' x 5'	22	20	19
6' x 6'	15	14	13
7' x 7'	12	11	11
8' x 8'	10	9	9
9' x 9'	7	7	7
10' x 10'	5	5	5
12' x 12'	4	4	3

#### COEFFICIENTS OF UTILIZATION - % (Zonal Cavity Method)

Effective Floor Reflectance 20%

PCC	80		70		50		30		10		0							
	PW	70	50	30	10	70	50	30	10	50	30	10	0					
0	47	47	47	47	45	45	45	45	43	43	43	42	42	42	40	40	40	39
1	45	45	44	44	44	44	43	43	42	42	42	41	41	40	40	39	39	39
2	44	43	42	42	44	43	42	41	41	41	40	40	40	39	39	39	39	38
3	43	42	41	40	43	42	41	40	41	40	39	40	39	39	39	39	38	38
4	43	41	40	39	42	41	40	39	40	39	38	39	39	38	39	38	38	37
5	42	40	39	38	41	40	39	38	39	38	38	39	38	37	38	38	37	37
6	41	39	38	37	41	39	38	37	39	38	37	38	38	37	38	37	37	36
7	41	39	38	37	40	39	38	37	38	37	37	38	37	36	38	37	36	36
8	40	38	37	36	40	38	37	36	38	37	36	37	37	36	37	36	36	36
9	39	38	37	36	39	38	37	36	37	36	36	37	36	36	37	36	36	35
10	39	37	36	35	39	37	36	35	37	36	35	37	36	35	36	36	35	35

3SQWW Square Lensed Wall Wash

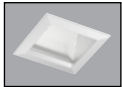

Self-Flanged



Flangeless



3" MR16 UNIVERSAL RECESSED WALL WASH

MR16 Halogen

IC43SQ / TC43SQ / TC943SQ with 3SQWW Trim

PHOTOMETRICS

PHOTOMETRIC REPORT

Catalog Number: IC43SQ 33SQWW CD SF

Test Number: PT01102003

Total Luminaire Efficiency: 53.2%

Luminaire Spacing Criteria: 0.76

Luminaire: Clear diffuse finish, lensed wall wash.

Lamps: One 37MR/IR/FL35

Luminance Data

Ang in Deg	Footlamberts	Candela/M <sup>2</sup>
45	2556	8756
55	568	1947
65	237	812
75	0	0
85	0	0

Zonal Lumen Summary

Zone	Lumens	%Lamp	%Fixture
0-30°	291	36.4	68.4
0-40°	359	44.9	84.5
0-60°	417	52.1	97.9
0-90°	426	53.2	100.0
90-180°	0	0	0
0-180°	426	53.2	100.0

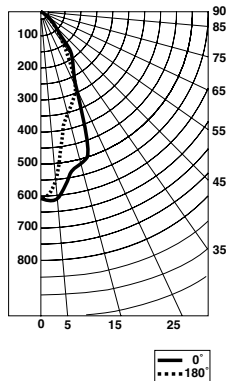

Candlepower Distribution (Candelas)

Degrees Vertical	0° Wall Wash	180° Downlight
0°	580	580
5°	579	543
15°	482	331
25°	247	215
35°	142	79
45°	80	42
55°	41	8
65°	22	2
75°	10	0
85°	0	0

Footcandles on Wall from Multiple Fixtures

Fixture Distance to Wall	18"						24"					
	18"		24"		18"		24"					
1'	13	12	13	11	7	11	7	6	7	5	4	5
2'	20	17	20	16	13	16	13	13	13	10	10	10
3'	17	18	17	13	12	13	14	14	14	11	10	11
4'	15	16	15	12	12	12	13	14	13	9	10	9
5'	13	12	13	9	9	9	12	12	12	9	9	9
6'	10	10	10	7	7	7	11	11	11	8	8	8
7'	7	8	7	6	6	6	9	9	9	7	7	7
8'	6	6	6	5	5	5	7	7	7	6	5	6
9'	5	5	5	4	4	4	6	6	6	5	5	5

\*Multipliers: Black - 0.7, Clear Diffuse - 0.95

\*Note: Multipliers are provided for estimating purposes only. Use IES photometric files for precise photometric information.

PHOTOMETRIC REPORT

Catalog Number: TC43SQ (TC943SQ) 3SQWW CD SF

Test Number: PT01102603

Total Luminaire Efficiency: 51.9%

Luminaire Spacing Criteria @ 90°: 0.72

Luminaire: Clear diffuse finish, lensed angle cut wall wash trim.

Lamps: One 50MR16/IR/FL35/C

Luminance Data @ 180° Downlight

Ang in Deg	Footlamberts	Candela/M <sup>2</sup>
45	3716	12732
55	700	2399
65	317	1085
75	0	0
85	0	0

Zonal Lumen Summary

Zone	Lumens	%Lamp	%Fixture
0-30°	436	36.3	69.9
0-40°	532	44.4	85.5
0-60°	610	50.8	98.0
0-90°	623	51.9	100.0
90-180°	0	0	0
0-180°	623	51.9	100.0

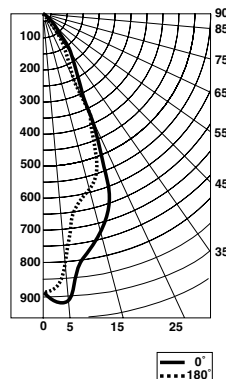

Candlepower Distribution (Candelas)

Degrees Vertical	0° Wall Wash	180° Downlight
0°	864	864
5°	885	794
15°	700	497
25°	412	296
35°	160	129
45°	108	61
55°	60	9
65°	34	3
75°	16	0
85°	2	0

Footcandles on Wall from Multiple Fixtures

Fixture Distance to Wall	18"			24"								
	18"	24"	18"	24"								
1'	19	14	19	17	8	17	10	8	10	8	6	8
2'	23	22	23	18	17	18	16	16	16	13	12	13
3'	26	25	26	20	18	20	18	17	18	14	13	14
4'	24	23	24	18	18	18	19	19	19	15	14	15
5'	19	19	19	14	14	14	19	18	19	14	14	14
6'	14	14	14	11	11	11	16	16	16	12	12	12
7'	11	11	11	8	8	8	13	13	13	10	10	10
8'	9	9	9	7	7	7	11	11	11	8	8	8
9'	8	8	8	6	6	6	9	9	9	7	7	7

\*Multipliers: Black - 0.7, Clear Diffuse - 0.95

\*Note: Multipliers are provided for estimating purposes only. Use IES photometric files for precise photometric information.